

RUFNEX[®] SERIES

ULTRA-LOW PROFILE
TORQUE WRENCHES

The RUFNEX Extra Low Clearance Torque wrenches are essential for limited clearance applications. The RUFNEX Series has many of the same specifications as the Hexpro Series, plus:

- Reduced Width
- Reduced Radius
- Fits Into Tight Locations
- Standard 4HP Power Head Will Operate This Ratchet Link

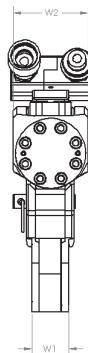
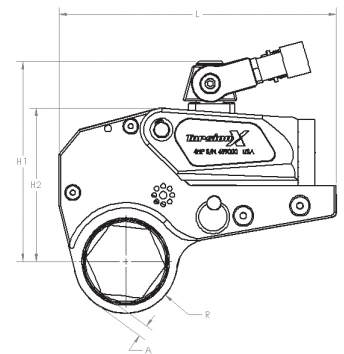

RUFNEX SPECS

Model	4RN-203		4RN-206		4RN-209	
Hex Size (A.F.)	2.3/16"	55mm	2.3/8"	60mm	2.9/16"	65mm
Power Head	5 lbs	2.27 kg	5 lbs	2.27 kg	5 lbs	2.27 kg
Ratchet Link	8 lbs	3.63 kg	8 lbs	3.63 kg	8 lbs	3.63 kg
L	9.65"	245.1 mm	9.65"	245.1 mm	9.65"	245.1 mm
H1	6.97"	177.0 mm	6.97"	177.0 mm	6.97"	177.0 mm
H2	5.34"	135.0 mm	5.34"	135.0 mm	5.34"	135.0 mm
W1	1.25"	31.75 mm	1.25"	31.75 mm	1.25"	31.75 mm
W2	2.60"	66.0 mm	2.60"	66.0 mm	2.60"	66.0 mm
A	.412"	10.5 mm	.418"	10.6 mm	.454"	11.5 mm
R	1.685"	42.8 mm	1.796"	45.6 mm	1.95"	49.5 mm

For more information call

1.304.744.9489

TorsionX.com